



Acrylic Displays

Acrylic Display Accessories
Display Cabinets
Spectacle Displays
Bulk Food Merchandising
Information Holders

Acrylic Displays

PAGE NO#

C1	Information Holders
C2	Information Holders
C3	Easels
C4	Easels
C5	Risers & Stairways
C6	Shoe Risers
C7	Tables
C8	Platforms
C9	Display Bases
C10	Timber Display Bases
C11	Jewellery Displays
C12	Jewellery Displays
C13	Watch Displays
C14	Jewellery Displays
C15	Display Cases
C16	Display Cases
C17	Spectacle Displays
C18	"PEG" Display System
C19	"PEG" Display System
C20	Spectacle Rod System
C21	Greeting Cards / tiered Racks
C22	Magazine Racks
C23	Competition Boxes
C24	Bulk Display Bins
C25	Bulk Display Bins
C26	Bakery Display cabinets

ANGLED INFORMATION HOLDERS

Clear acrylic.

- AP0400** 95mm (W) x 55mm (H) (Bus. Card)
 - AP0401** 105mm(W) x 148mm (H) (A6)
 - AP0402** 100mm(W) x 210mm (H) (DL)
 - AP0403** 148mm(W) x 210mm (H) (A5)
 - AP0404** 210mm(W) x 297mm (H) (A4)
 - AP0405** 297mm(W) x 420mm (H) (A3)
- For landscape format specify suffix 'L', eg, AP0403L.

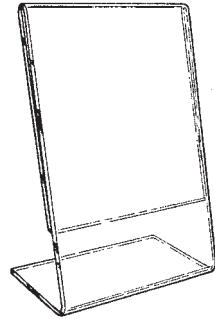

VERTICAL INFORMATION HOLDERS

Clear acrylic.

- AP0411** 105mm (W) x 148mm (H) (A6)
 - AP0412** 100mm (W) x 210mm (H) (DL)
 - AP0413** 148mm (W) x 210mm (H) (A5)
 - AP0414** 210mm (W) x 297mm (H) (A4)
 - AP0415** 297mm (W) x 420mm (H) (A3)
- For landscape format specify suffix 'L', eg, AP0414L.

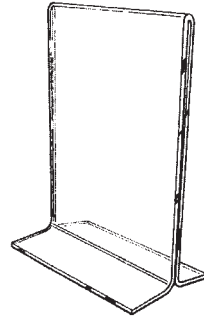

VERTICAL INFORMATION HOLDERS TOP LOADED

These quality stands are manufactured from 4mm thick clear acrylic for a more upscale appearance.

- AP0417** 148mm (W) x 210mm (H) (A5)
- AP0418** 210mm (W) x 297mm (H) (A4)

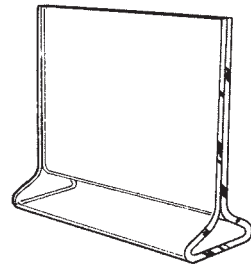

THREE-SIGN TRIANGLE FRAMES

Clear acrylic.

- AP0421** 105mm (W) x 148mm (H) (A6)
- AP0422** 100mm (W) x 210mm (H) (DL)
- AP0423** 148mm (W) x 210mm (H) (A5)

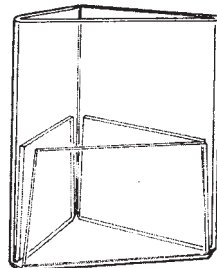

INFORMATION HOLDERS WALL-MOUNT (PLAIN)

Clear acrylic.

- AP0443/PL** 148mm (W) x 210mm (H) (A5)
 - AP0444/PL** 210mm (W) x 297mm (H) (A4)
 - AP0445/PL** 297mm (W) x 420mm (H) (A3)
 - AP0446/PL** 420mm (W) x 594mm (H) (A2)
 - AP0447/PL** 594mm (W) x 840mm (H) (A1)
 - AP0448/PL** 840mm (W) x 1188mm (H) (A0)
- For landscape format specify suffix 'L', eg, AP0446/PLL.

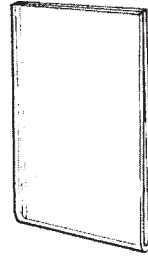

INFORMATION HOLDERS WALL-MOUNT (WITH HOLES)

Clear acrylic.

- AP0443/2H** 148mm (W) x 210mm (H) (A5)
 - AP0444/2H** 210mm (W) x 297mm (H) (A4)
 - AP0445/2H** 297mm (W) x 420mm (H) (A3)
 - AP0446/2H** 420mm (W) x 594mm (H) (A2)
 - AP0447/2H** 594mm (W) x 840mm (H) (A1)
- For landscape format specify suffix 'L', eg, AP0445/2HL.



INFORMATION HOLDERS WALL-MOUNT (WITH ADHESIVE TAPE)

Clear acrylic with 2 x vertical strips of white double-sided foam tape.

- AP0443/DST** 148mm (W) x 210mm (H) (A5)
 - AP0444/DST** 210mm (W) x 297mm (H) (A4)
 - AP0445/DST** 297mm (W) x 420mm (H) (A3)
 - AP0446/DST** 420mm (W) x 594mm (H) (A2)
 - AP0447/DST** 594mm (W) x 840mm (H) (A1)
- For landscape format specify suffix 'L', eg, AP0443/DSTL.

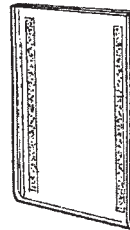

INFORMATION HOLDERS WALL-MOUNT (TO SUIT ALUMINIUM WALL STRIP)

Top hook clips over aluminium wall strip #1535. Wall strip concealed behind poster. Allows for easy removing of individual products.

- AP0424** 210mm (W) x 297mm (H) (A4)
- AP0425** 297mm (W) x 420mm (H) (A3)
- AP0426** 420mm (W) x 594mm (H) (A2)
- AP0427** 594mm (W) x 840mm (H) (A1)

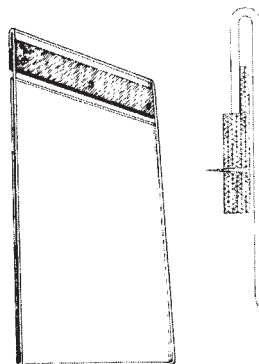

ADJUSTABLE EASELS

Adjustable, injection-moulded folding easels.
Folds completely flat when not in use.

AP037

75mm (H) x 60mm (W) x 90mm (D)

AP038

85mm (H) x 80mm (W) x 125mm (D)

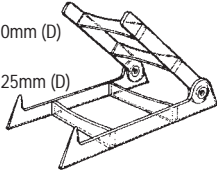

MINIATURE EASELS

Originally designed to display agateslabs, they have been found to be an ideal way to display framed miniatures, tiles, clocks and many other small flat items.

AP030 Holds items up to 12mm thick
50mm (H) x 55mm (W) x 55mm (D)

AP030A Holds items up to 20mm thick
57mm (H) x 75mm (W) x 60mm (D)

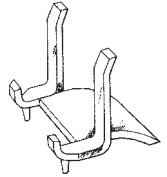

WIRE-BACK FOLDING EASEL

Injection-moulded clear plastic bas with adjustable white vinyl-coated wire back.

AP039 165mm (H) x 125mm (W) x 190mm (D)

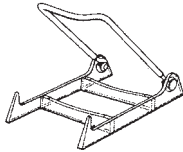

TRIANGULAR

Excellent for coins, medallions, framed miniatures and much more.
Stackable for compact shipping.

AP031
32mm (H) x 25mm (W) x 32mm (D)

AP032
55mm (H) x 45mm (W) x 50mm (D)

AP034
85mm (H) x 80mm (W) x 48mm (D)

This larger triangular easel has a deeper display edge.

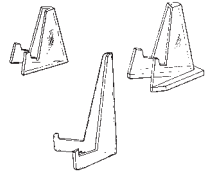

BOX EASELS

Convenient counter display for books, stationery, software, etc. 3mm thick clear acrylic. Base 40mm deep.

AP027 75mm (H) x 50mm (W)

AP028 125mm (H) x 75mm (W)

AP029 175mm (H) x 100mm (W)

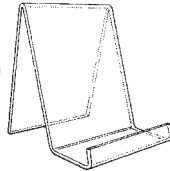
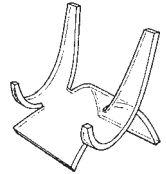

PLATE EASELS

Laser cut and fabricated from 3mm clear acrylic. Best for holding flat items.

AP040
60mm (H) x 55mm (W) x 50mm (D)

AP041
90mm (H) x 100mm (W) x 80mm (D)
Use AP041 for collectors plates



LARGE EASELS

Heavy duty 4mm thick acrylic for bulky items, eg. handbags, etc...

AP033 100mm (H) x 100mm (W)

AP035 175mm (H) x 100mm (W)

AP036 250mm (H) x 100mm (W)

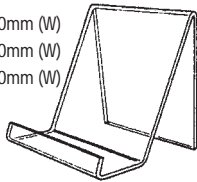
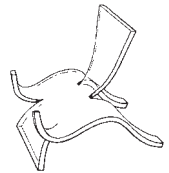

PLATE & BOWL EASEL

Designed to accommodate thicker items than the Plate Easel above.

AP042
90mm (H) x 60mm (W) x 80mm (D)

AP043
120mm (H) x 100mm (W) x 120mm (D)



MOBILE PHONE EASELS

Laser cut sculptured design from 3mm thick clear acrylic.
Internal pocket dimension: 65mm (W) x 30mm (D).

AP053 130mm (H) x 70mm (W) x 125 (D)



DIAGONAL TILE RACKS

Excellent for displaying a co-ordinated range of ceramic tiles and other flat objects.

AP221

275mm (H) x 90mm (W) x 275mm (D)
Slot depth 10mm

AP222

360mm (H) x 115mm (W) x 360mm (D)
Slot depth 16mm

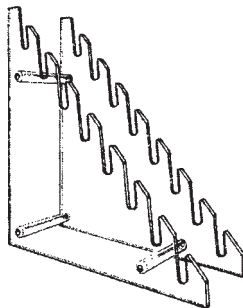

LARGE FABRICATED EASELS

The double-bend construction of these clear acrylic easels gives them extra stability and their rounded lines and polished edges make them the unobtrusive choice for displaying everything from plates, platters, prints and framed pictures to heavy museum displays. The back includes holes for wall-mounting.

AP010

150mm (H) x 130mm (W) x 125mm (D)

AP011

180mm (H) x 170mm (W) x 200mm (D)

AP012

300mm (H) x 260mm (W) x 260mm (D)

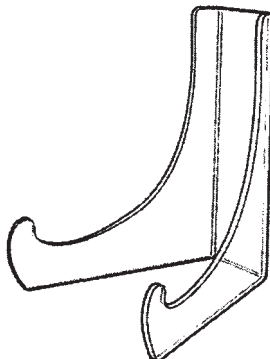

TIERED EASELS

Make the most of counterspace by displaying plates, prints etc... on these multi-tiered easels. Constructed with threaded acrylic rods so that they pack flat for easy shipping

AP054

260mm (H) x 90mm (W) x 170mm (D)

AP050

390mm (H) x 165mm (W) x 260mm (D))

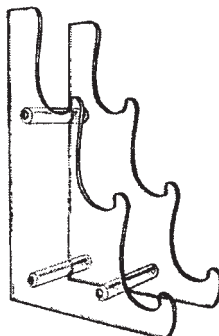

RISERS

Our range of risers give you a simple method of adding interest to your displays by creating different levels. Our standard range of risers is manufactured from 3mm thick acrylic while the Heavy-Duty risers are manufactured from 6mm thick acrylic with diamond-polished edges for a distinctive appearance.

STANDARD - 3mm thick clear acrylic

- AP020** 50mm (H) x 140mm (W) x 200mm (D)
- AP021** 100mm (H) x 160mm (W) x 200mm (D)
- AP022** 150mm (H) x 180mm (W) x 200mm (D)
- AP014** 50mm (H) x 50mm (W) x 50mm (D)
- AP015** 75mm (H) x 75mm (W) x 75mm (D)
- AP023** 100mm (H) x 100mm (W) x 100mm (D)
- AP024** 150mm (H) x 150mm (W) x 150mm (D)
- AP025** 200mm (H) x 200mm (W) x 200mm (D)

HEAVY-DUTY - 6mm thick clear acrylic

- AP016** 200mm (H) x 200mm (W) x 200mm (D)
- AP017** 250mm (H) x 250mm (W) x 250mm (D)
- AP018** 300mm (H) x 300mm (W) x 300mm (D)
- AP019** 350mm (H) x 350mm (W) x 350mm (D)
- AP013** 400mm (H) x 400mm (W) x 400mm (D)

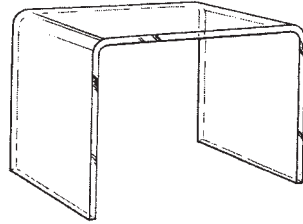

Also available in Frosted Acrylic - use suffix "F"

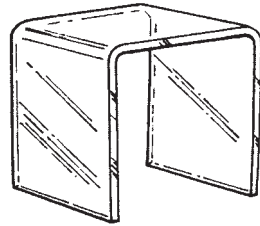

STAIRWAYS

THREE STEP STAIRS - Ideal for displaying small jewellery, perfumes & accessory items. Acrylic rod legs attach with stainless steel screws. Each shelf measures 75mm deep, each step is 65mm high.

- AP044** 210mm (H) x 150mm (W) x 225mm (D)
- AP045** 210mm (H) x 300mm (W) x 225mm (D)
- AP046** 210mm (H) x 450mm (W) x 225mm (D)

STAIRWAY SIGN ATTACHMENT

Insert your information or photograph into this one-piece sign holder. Sold separately to stairs. Signage height: 100mm

- AP0445** 150mm (W)
- AP0455** 300mm (W)
- AP0465** 450mm (W)

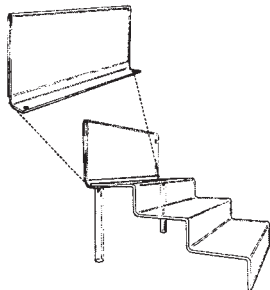
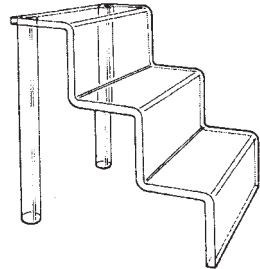

SHOE RISERS

Narrow risers allow you to create an effective shoe display with various heights. Manufactured from 3mm thick acrylic.

AP005 50mm (H) x 200mm (W) x 75mm (D)

AP006 100mm (H) x 200mm (W) x 75mm (D)

AP007 150mm (H) x 200mm (W) x 75mm (D)

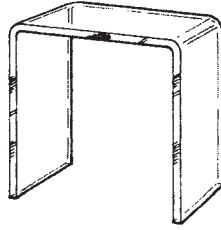

SLOPING SHOE RISER

Narrow riser with heel stop.
Manufactured from 4mm thick acrylic.

AP001 50mm (H) x 200mm (W) x 75mm (D)

AP002 100mm (H) x 200mm (W) x 75mm (D)

AP003 150mm (H) x 200mm (W) x 75mm (D)

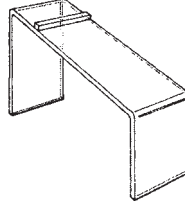

SCROLL TYPE SHOE RISER

With heel rest. Manufactured from 5mm thick acrylic.

AP060 110mm (H) x 50mm (W) x 170mm (D)

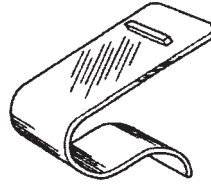

SHOE REST

Convenient angle pieces for creating angled displays.

AP064 50mm (W)

AP066 100mm (W)

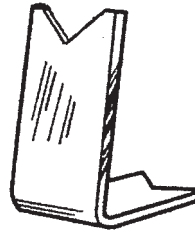

SHOE RIBBON

Supports women's strapped shoes for display.

AP059 150mm (H) x 16mm (W) x 200mm (D)



DISPLAY RINGS

Display anything from marbles to bowling balls or shallow pottery bowls on these injection-moulded ring shaped displays.

AP068 12mm (H) x 25mm (W)

AP068A 25mm (H) x 40mm (W)

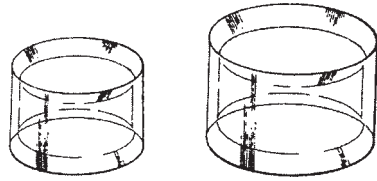

TABLES

These injection-moulded tables offer a convenient method of providing small "build-ups" to your display. Alternatively, you can use them upside down to display irregular-shaped mineral, fossil or seashell exhibits.

AP047 40mm (H) x 85mm (W) x 65mm (D)

AP048 40mm (H) x 100mm (W) x 100mm (D)

AP049 55mm (H) x 155mm (W) x 110mm (D)

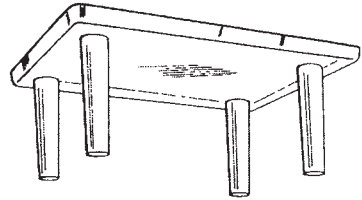

COUNTERTOP TABLES

Tables are constructed with an acrylic platform mounted on clear acrylic rods with stainless steel screws. (Other leg heights are available - please enquire)

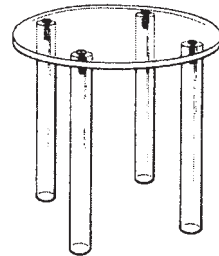

ROUND TABLES

AP356 200mm (H) x 200mm (W)

AP357 200mm (H) x 300mm (W)

AP358 200mm (H) x 400mm (W)

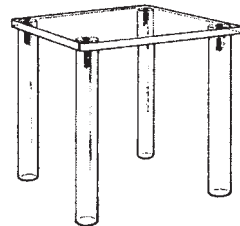

SQUARE TABLES

AP061 200mm (H) x 200mm (W) x 200mm (D)

AP062 200mm (H) x 300mm (W) x 300mm (D)

AP063 200mm (H) x 400mm (W) x 400mm (D)

MULTI-LEVEL INTERLOCKING PLATFORM

These interlocking components on these platforms ship unassembled and quickly slide together to create an attractive multi-level display. The oval shaped platforms are notched to prevent sliding.

AP065 175mm (H) x 275mm (W) x 225mm (D)

Platform size: 150mm x 75mm

AP067 350mm (H) x 525mm (W) x 475mm (D)

Platform size: 275mm x 175mm

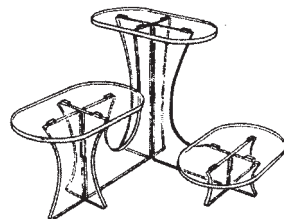

PLATFORMS

ADJUSTABLE MULTI-PLATFORM DISPLAYS

Create visual impact with our 6 platform counter-top display. They make great use of variable counter or shelf space and are easily adjustable to a variety of positions. Constructed from oval-shaped 6mm thick polished acrylic platforms assembled with round acrylic threaded rods and stainless steel screws.

AP051 325mm (H) x 170mm (W) (variable)

Platform size: 175mm x 100mm

AP052 325mm (H) x 1200mm (W) (variable)

Platform size: 275mm x 175mm

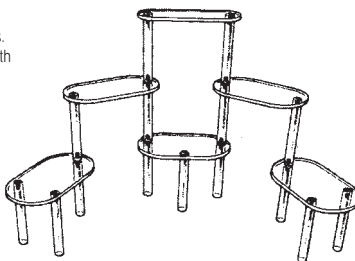

FIVE-SHELF TOWER

Constructed from circular 6mm thick polished acrylic shelves assembled with round acrylic threaded rods and stainless steel screws. Can be assembled in many configurations.

AP004 525mm (H) x 250mm (Base dia)

Platform diameter: 150mm

Distance between shelves: 100mm

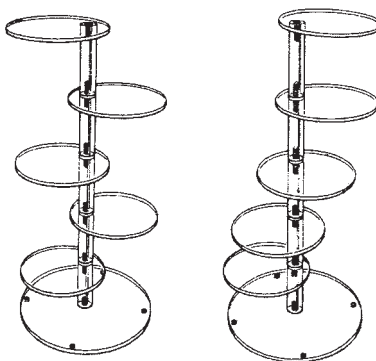

ROUND BASE RISERS

Constructed from circular 4mm thick polished acrylic platforms connected to a circular 6mm thick acrylic base with round acrylic threaded rods and stainless steel screws.

THREE PLATFORM DISPLAY

AP368 Base dia: 200mm

Platform diameter: 75mm

Rod heights: 2 @ 100mm 1 @ 150mm

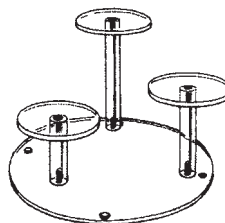

FIVE PLATFORM DISPLAY

AP369 Base dia: 200mm

Platform diameter: 75mm

Rod heights: 2 @ 100mm 1 @ 150mm

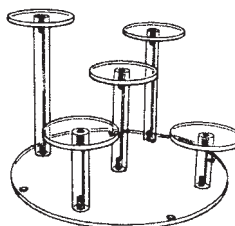

DISPLAY BLOCKS & BASES

Now you can make your product really stand out while adding value by placing it on one of our polished acrylic blocks. Utilizing the latests diamond polishing technology that will produce a crystal-clear finish on edges and bevels, these blocks will provide a beautiful compliment to you valuable merchandise. All our blocks come with four clear stick on feet, so that you can choose to attach them or not.

BEVELLED TOP BASES

20mm thick acrylic with 45 bevel around 4 sides.
With polished corner cut.

- AP280** 75mm (H) x 75mm (W)
- AP281** 150mm (H) x 150mm (W)
- AP282** 200mm (H) x 200mm (W)
- AP283** 250mm (H) x 250mm (W)
- AP284** 300mm (H) x 300mm (W)
- AP285** 150mm (H) x 75mm (W)
- AP286** 250mm (H) x 150mm (W)
- AP287** 300mm (H) x 200mm (W)

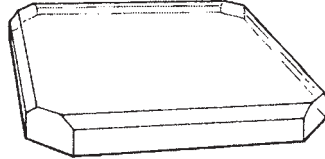

OCTAGONAL BEVELLED TOP BASES

20mm thick with 45 bevel.

- AP290** 75mm (H) x 75mm (W)
- AP291** 100mm (H) x 100mm (W)
- AP292** 150mm (H) x 150mm (W)
- AP293** 200mm (H) x 200mm (W)
- AP294** 150mm (H) x 100mm (W)
- AP295** 200mm (H) x 150mm (W)

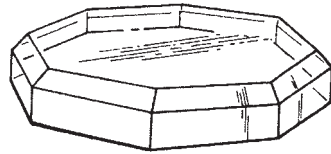

LABEL BASES

15mm thick acrylic with 60 bevel along front edge.
The angled area is for an identifying label or plaque.
Label space is 15mm high.

- AP297** 75mm (H) x 75mm (W)
- AP298** 100mm (H) x 100mm (W)
- AP299** 150mm (H) x 150mm (W)

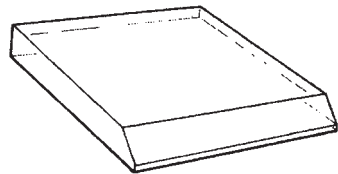

ROUND BEVELLED BASES

20mm thick acrylic with 45 bevel.

- AP275** 75mm dia.
- AP276** 125mm dia.
- AP277** 175mm dia.



TIMBER DISPLAY BASES

SOLID ACRYLIC COLUMNS

AP269 - 50mm (H) x 38mm (W)

AP272 - 75mm (H) x 38mm (W)

AP273 - 100mm (H) x 38mm (W)

AP274 - 50mm (H) x 50mm (W)

AP278 - 75mm (H) x 50mm (W)

AP279 - 100mm (H) x 50mm (W)

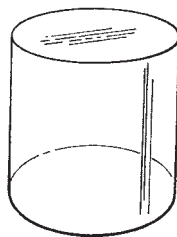

SOLID TIMBER BASES

Clear laquered timber bases with rebated edge designed for locating acrylic covers. 200mm thick walnut timber.

SQUARE

AP260 150mm (H) x 150mm (W)

AP261 200mm (H) x 200mm (W)

AP262 250mm (H) x 250mm (W)

AP263 300mm (H) x 300mm (W)

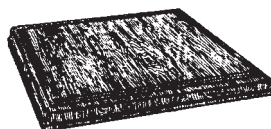

RECTANGULAR

AP265 230mm (H) x 150mm (W)

AP266 300mm (H) x 200mm (W)

AP267 400mm (H) x 250mm (W)

AP268 500mm (H) x 300mm (W)



CIRCULAR

Designed for use with glass domes below.

AP270 115mm Dia

AP271 200mm Dia

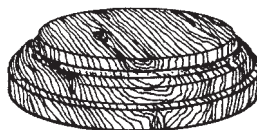

GLASS DOMES

Use with or without timber bases to create a stunning display.

AP370 200mm (H) x 115mm Dia

AP371 300mm (H) x 200mm Dia

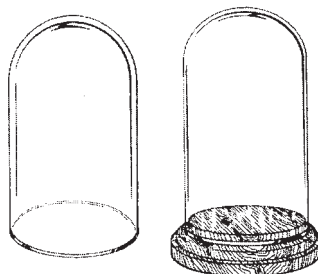

RING DISPLAYS

The ring clip ramp is designed for use with our moulded ring clips (purchased separately). The ramp has 6 slots - depending on the size of the ring, each slot will hold up to 7 rings.

AP383 80mm (H) x 150mm (W) x 190mm (D)

AP7337 - Ring Clips

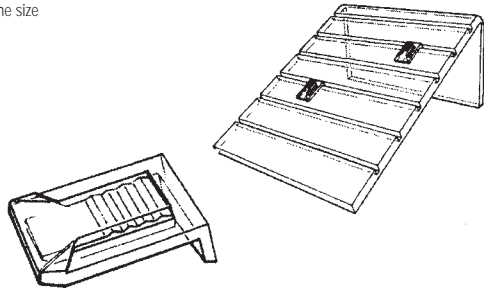

EARING/PENDANT DISPLAYS

Oval or heart-shaped stand displays a pair of earrings and a necklace together.

AP460 105mm (H) x 90mm (W) x 60mm (D) - Oval shape

AP461 70mm (H) x 90mm (W) x 45mm (D) - Heart-shape

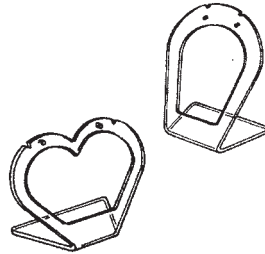

STAND

For single pair of earrings.

AP462 65mm (H) x 50mm (W) x 40mm (D)

AP463 90mm (H) x 50mm (W) x 40mm (D)

AP464 110mm (H) x 50mm (W) x 40mm (D)

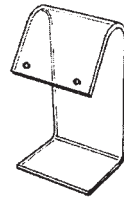

ANGLED-BACK STAND

AP467 150mm (H) x 120mm (W) x 75mm (D)

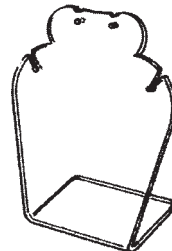

ROUND GEM BOXES

Injection moulded round box with snap-on lid.
Boxes are filled with white felt-topped sponge.

AP055 13mm (H) x 25mm (D)

AP056 13mm (H) x 38mm (D)



GEM BOX TRAYS

These acrylic trays present 12 round gem boxes on a 30 angle.

AP057 85mm (H) x 150mm (W) x 135mm (D)

AP058 85mm (H) x 215mm (W) x 180mm (D)

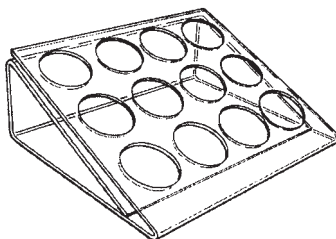

BRACLET BAR

Small stand with bevelled acrylic base.
Clear acrylic rod: 150mm long.

AP234 Single rod - Height 100mm

AP224 Triple rod - 100mm, 180mm, 260mm

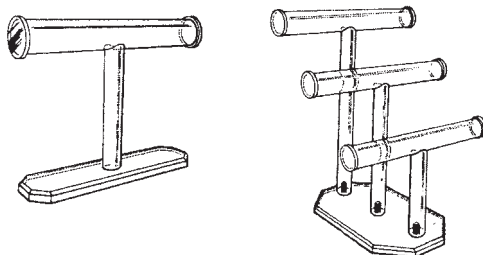

NECKLACE STAND

Injection-moulded base and top with acrylic tube in between.
Base dimension: 150mm x 150mm. Top bar dimension 400mm long.
Tube height: 300mm (can be trimmed to suit your application).

AP384

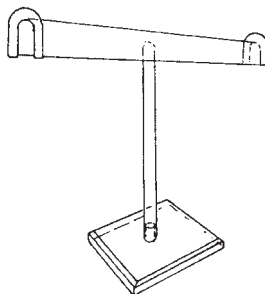

WATCH PEDESTALS

Single watch display on square 12mm thick polished acrylic base.

AP238 100mm (H) x 50mm (W) x 50mm (D)

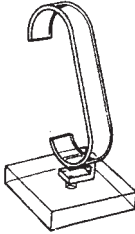

BRACLET/WATCH RAMP

Wave-shaped ramp gives a graceful curve to draped necklaces, bracelets or watches.

AP239 45mm (H) x 45mm (W) x 300mm (D)

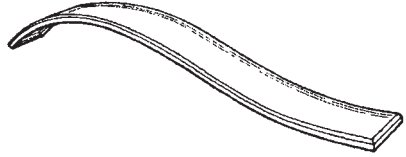

DOUBLE DOOR LOCKING CASE

This case has 5 angled shelves with 25mm lip and is designed to hold up to 120 ring boxes. There is a locking door on either side, and the case revolves on a lazy susan base.

AP372 550mm (H) x 330mm (W) x 180mm (D)

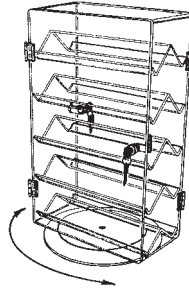

"FLIGHT SYSTEM" - SPECTACLE DISPLAYS

* At last, a spectacle display system that angles eyewear to ideal vantage points. Frames that typically sell in the limited space between 1000 – 1650mm high. Merchandise above or below these points does not stare appealingly at the patient. Our new FLIGHT SYSTEM overcomes this problem by allowing frames to be viewed for maximum impact from 750 – 1900mm, thereby increasing sales opportunities.

* The hinged bridge section of the frame holder (called the Shuttle) moves up and down in defined increments, allowing you to angle frames up if they are located at the bottom of the display (the "takeoff" position), or angle them down if they are at the top of the display (the "landing" position).

* The new frame holder is so versatile that it can even be used on horizontal surfaces so that, in a glass case, the frames can be cleverly positioned to "stare" straight up at the viewer.

* The Shuttle is a durable is a durable component with a coating that provides a soft landing for your frames. It pops easily in and out of the Launch Pad – the moulded fitting that is inserted into a pre-machined panel. Contact our design department to discuss your panel layout and mounting options.

AP7345 The "Shuttle" frame holder – injection-moulded hinged design. Available in silver(SIL) or translucent(WH).

AP7346 The "Launch Pad"
– wall fitting, presses in to pre-machined hole in MDF panels.



"Shuttles" shown on horizontal configuration.



"Shuttle"
Take-off
position



"Shuttle"
Landing position

ROTATING TOWERS

For use with ring pad or J-bar inserts in single or double height. Has angled mirror face on the four corners. Also available with a clear acrylic locking cabinet - customer is able to rotate the display. Please note: inserts are not included with the towers, and must be ordered separately.

AP396 265mm (H) x 190mm (W) x 190mm (D)

AP397 280mm (H) x 300mm (W) x 300mm (D)

AP398 495mm (H) x 190mm (W) x 190mm (D)

AP399 510mm (H) x 300mm (W) x 300mm (D)

With locking case

For single height units, order your choice of 4 inserts per stand or 8 inserts for the double unit.

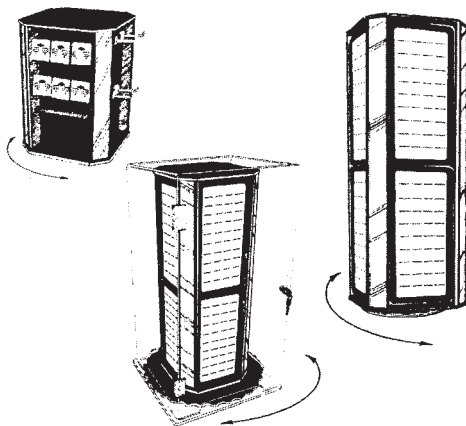

RING PAD INSERTS

Vacuum-formed black plastic surround with white foam insert with 36 ring slots. Use singly inside showcases or as an insert for our rotating towers.

AP381 240mm (H) x 115mm (W) x 20mm (D)

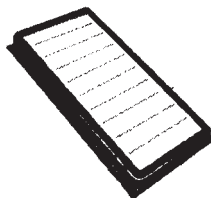

J-BAR INSERTS

Black acrylic back panel with "J"-bar attached for jewellery cards, or hooks can be added to hand multiple cards, keychains, chokes or bracelets. Order hooks separately.

AP382 240mm (H) x 115 (W)

With 2 "J"-bars - spaced 110mm apart

AP382A 240mm (H) x 115mm (W)

With 3 "J"-bars - spaced 70mm apart

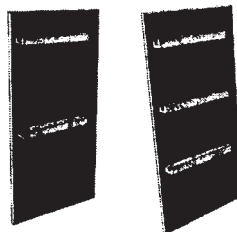

HOOKS

Simply slide on a "J"-bar ribbed design for extra strength.

AP7136 38mm (L)

AP7137 50mm (L)

AP7138 75mm (L)



COUNTER LOCKING CASE

Rectangular shaped tray with hinged lockable lid.

AP387 70mm (H) x 450mm (W) x 300mm (D)

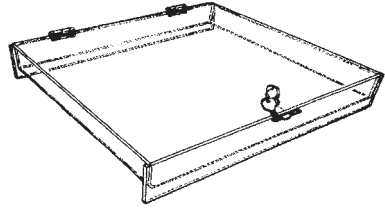

HINGED DOOR CASES

With fixed shelves, solid back panel laser cut-out door panel/s for maximum strength design. Includes 2 x Mini Camlocks

AP390 600mm (H) x 450mm (W) x 190mm (D)
Includes 2 x shelves and base. Spaced 190mm apart.
Single door.

AP391 750mm (H) x 600mm (W) x 190mm (D)
Includes 3 x shelves and base. Spaced 185mm apart.
Double door (pictured).

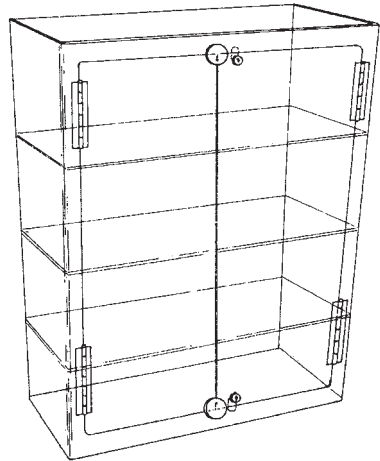

SLANTED FRONT CASE

Angled front with fixed shelves. Has sliding back panel for access.

AP380 450mm (H) x 400mm (W) x 250mm (D)
Included 2 shelves Spaced 145mm apart.

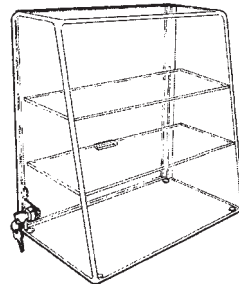

DISPLAY CASES

OCTAGONAL ROTATING DISPLAY CASES

Our range of display cases offer a convenient method of displaying jewellery, fine china and a whole range of accessories. They offer all-round viewing of your product by either a hand-turning knob on top or a battery operated turntable for constant motion. All cases include a cam lock and two keys. Circular shelves offer adjustable height on the central arm.

HAND OPERATED

AP385 450mm (H) x 300mm (W) x 300mm (D)

AP386 600mm (H) x 400mm (W) x 400mm (D)

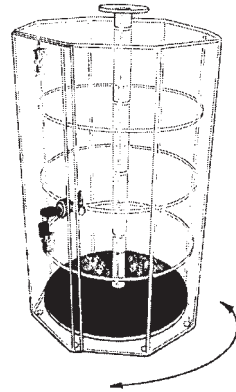

MOTORIZED

What could draw attention to your products more than displaying them in constant motion? A compact battery-operated turntable under the base shelf will run for months on 2 x "D" size batteries.

AP394 525mm (H) x 300mm (W) x 300mm (D)

3 shelves including base.

AP395 675mm (H) x 400mm (W) x 400mm (D)

4 shelves including base.

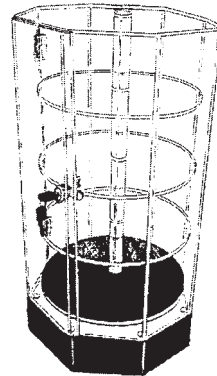

ROTATING WATCH DISPLAY

You can convert all of the above cases in to watch displays with our special Watch Peg Clip. Simply follow these steps to order:

1. Order any of the standard display cases (either octagonal ones on this page or locking cases on page C15)
2. Work out how many watches you wish to display per shelf.
3. Order the appropriate number of item **AP240**.

This is the watch clip including attaching to the shelf according to your specified configuration.

(Watch clips are removable from the stand for easy cleaning)

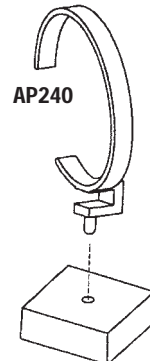

REVOLVING SPECTACLE DISPLAYS

Black base on lazy susan base with clear injection-moulded eyeglass holders.

AP252 350mm x 350mm - Hexagonal Base
Height 600mm - Displays 48 pairs



AP250 200mm x 200mm - Square Base
Height 600mm - Displays 24 pairs

SPECTACLE DISPLAYS

Six frame Counter Stand

AP235 195 (W) x 500mm (H)



SPECTACLE DISPLAYS

J-style shelves on acrylic rod upstands with a bevelled 6mm thick acrylic base available in single or multiple styles.

AP201 100mm (H) x 75mm (W) x 75mm (D)

AP201A 150mm (H) x 75mm (W) x 75mm (D)

Single

AP203 75/125/175mm (H) x 75mm (W) x 150mm (D)

Three

AP204 50/100/150/200/250mm (H) x 75mm (W) x 150mm (D)

Five

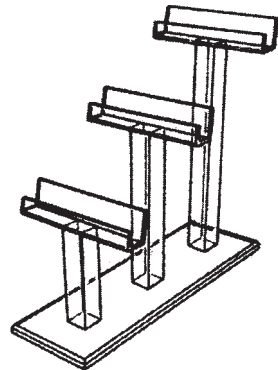

'PEG' DISPLAY SYSTEM

ACRYLIC PEG SYSTEM

Create some sensational effects with this simple display system. Based on a precision-drilled acrylic back panel with a range of accessory clips for displaying spectacles, watches or create your own accessories with our plain back plates.

Acrylic back panel available in clear on a wide range of translucent and opaque colours.

Available as direct wall mount version with spacer blocks behind panel or as plain panel for mounting onto suspended cable system or with "SUSPENSE" stand-off fittings.

PANELS

Panel size 800mm x 600mm (There is a 50mm border around the edges of the panel before the holes start).

AP200 Clear Acrylic

AP202 Coloured Acrylic
Plain Panel

Wall-mounted panel has 6mm thick spacers behind panel - 8 mountings per panel. Mounting holes are countersunk so that screw fixing will not interfere with placement of accessories.

AP205W Clear Acrylic

AP206W Coloured Acrylic
Wall-mounted panel

ACCESSORIES

Display prongs, clear plastic.

AP7325 50mm (L)

AP7326 100mm (L)

AP7327 150mm (L)

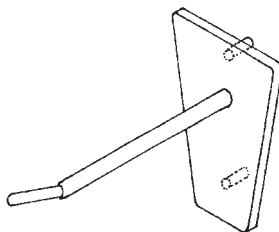
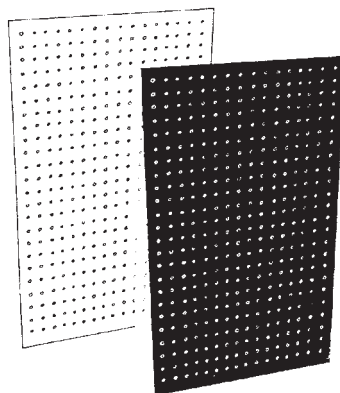

HINGED DOOR CASE WITH "PEG" SYSTEM BACK

Acrylic peg panel backing system allows for adjustable placement of accessories - prongs, spectacle clips, signs, etc. Backing available in clear or coloured acrylic (see page C19 for accessories).

AP433 750mm (H) x 600mm (W) x 190mm (D)
With clear acrylic back panel

AP434 750mm (H) x 600mm (W) x 190mm (D)
With coloured acrylic back panel (specify colour).

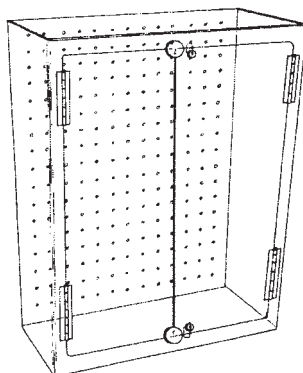

SPECTACLE HOLDERS

Clear plastic, for folded spectacles.

AP7329 50mm (L)

AP7336 80mm (L)

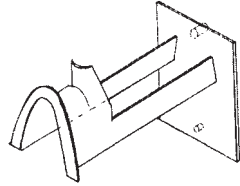

BACKPLATES

Clear plastic. Use these back plates for attaching signage or other products, or we can custom manufacture a solution for you - eg. small shelves, acrylic sandwich panels for signs etc.

AP7320 60mm (W) x 20mm (H)

AP7321 40mm (W) x 50mm (H)

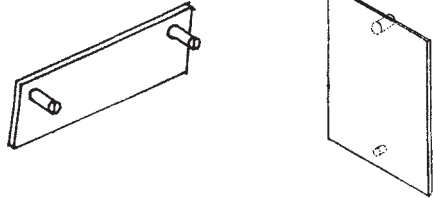

WATCH CLIP

Clear plastic.

AP7340 105mm (W) x 75mm (H)

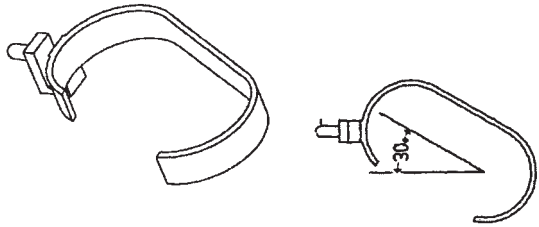

SIGNHOLDER

Acrylic sandwich panel with "peg" attachment

AP258

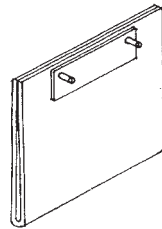

LEAFLET HOLDER

DL size brochure holder with "PEG" attachment.

AP259

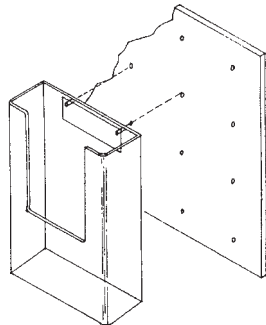

SPECTACLE ROD SYSTEM

SPECTACLE ROD SYSTEM

This method of displaying spectacle is a proven, effective display system, offering flexibility of arrangement and superior merchandising that makes your product the feature.

Choose from clip-on holders that allow for flexible merchandising according to seasonal variations in product density or our glued on fittings that have a locking operation.



Rod-Mount Fitting
With tightening screw.
For mounting onto wall
or counter top.

AP237

Wall-Spacer Fitting
Use for wall-mounting
of straight rods. Spacer
length-130mm. May be
trimmed to suit.

AP236

Straight Rod - 1800mm
(can be trimmed to size)

AP249

Rod colours - Clear (CL),
or Silver (SIL).

Bent Rods
(for wall mounting)

AP244/8 - 800mm

AP244/10 - 1000mm

AP244/12 - 1235mm

GLUE-ON FITTINGS

These are priced individually including glueing onto rods.
Standard spacing - 70mm between centres.



Order your rod separately
and the required number of
glue-on attachments.

AP230

FOILER-LOCK

The most economical method of screwing frames to the rod
with glue-on fittings. Hinged arm locks onto fitting and is
released by our special key (purchased separately).



Foiler-locks are installed on
the rod at the same time as
glue-on fittings and can't be
added later.

AP254 - Foiler locking mechanism

Add to glue-on fittings above.

AP255 - Key

LIFT KIT

Used on slender top frames to
make them sit securely upright.
Use on glue-on fitting and original
snap (below).

AP264 - Pack of 25

AP257 - Pack of 150

AP256 - Pack of 300

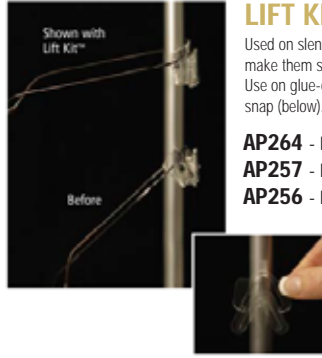

SPECTACLE CLIPS

Snaps securely onto rods at your desired location.

Original Snap

AP7323 - Standard

AP7324 - Deeper style
for thicker rims & goggles.

Curved Shelf Rest
(for curved frames)

AP7330

Spectacle Shelf Rest (straight)

AP7331



CLIP-ON ATTACHMENTS

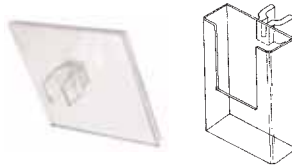

Sign holder - A7
Landscape sleeve.

AP241

DL Brochure
Holder.

AP251

Mirror
120 x 120mm

AP253

GREETING CARD RACKS

This range of card stands provides a very convenient method of displaying cards in a countertop or wall-mounting application.

Top row has keyholes for wall-mounting or for use with AP1519 hooks for PLANKWALL.

- AP304A** 3 tier 340mm (H) x 300mm (W) x 190mm (D)
- AP310A** 3 tier 340mm (H) x 600mm (W) x 190mm (D)
- AP311A** 3 tier 340mm (H) x 900mm (W) x 190mm (D)
- AP312A** 3 tier 340mm (H) x 1200mm (W) x 190mm (D)
- AP309A** 4 tier 420mm (H) x 300mm (W) x 240mm (D)
- AP313A** 4 tier 420mm (H) x 600mm (W) x 240mm (D)
- AP314A** 4 tier 420mm (H) x 900mm (W) x 240mm (D)
- AP315A** 4 tier 420mm (H) x 1200mm (W) x 240mm (D)

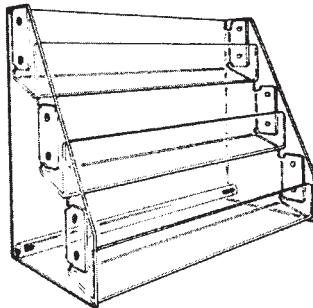

BOOK STACKING TRAY

Display books or magazines in a face-forward view with a slight angle back.

- AP332** 200mm (H) x 130mm (W) x 150mm (D)
- AP333** 275mm (H) x 230mm (W) x 210mm (D)

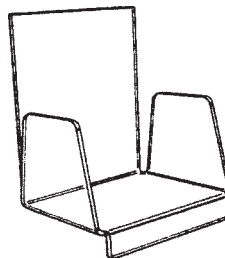

TIERED DISPLAY TRAYS

This unit features one-piece bent trays and come with transparent screws for assembly. Dividers are available that clip on to the front of the tray. Choose from 2 lengths and 3 or 4 tier.

- AP211** 3 tier 170mm (H) x 310mm (W) x 300mm (D)
 - AP212** 3 tier 170mm (H) x 460mm (W) x 300mm (D)
 - AP213** 4 tier 220mm (H) x 310mm (W) x 400mm (D)
 - AP214** 4 tier 220mm (H) x 460mm (W) x 400mm (D)
- Each tray measures 50mm (H) x 100mm (D)

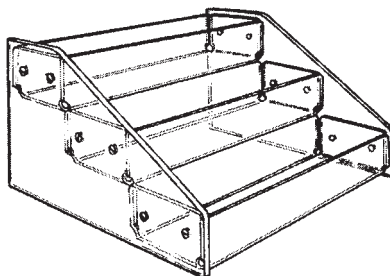

MAGAZINE RACKS

MAGAZINE TENSION RACKS

Double-sided racks provide an excellent means of displaying a stack of magazines with full cover viewing. Tension arm in each pocket holds a group of single magazines to the front of the socket. Easy access from the sides.

COUNTERTOP

4 pockets back to back for a total of 8 pockets.

AP656 600mm (H) x 450mm (W) x 180mm (D)

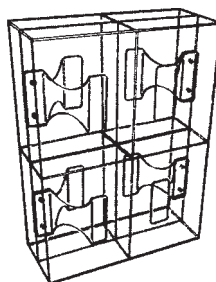

FLOOR STANDING

16 pocket rack on heavy timber base for stability. Base in black melamine finish.

AP657 600mm (H) x 450mm (W) x 180mm (D)

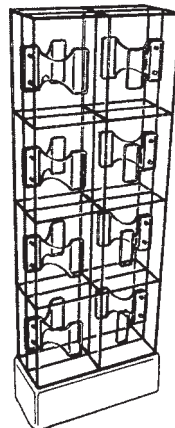

NEWSPAPER RACK

Clear acrylic surround with 4 shelves including base. Base in black melamine finish on castors for easy maneuverability. Open front shelves with a lip on the front.

AP659 1250mm (H) x 430mm (W) x 360mm (D)

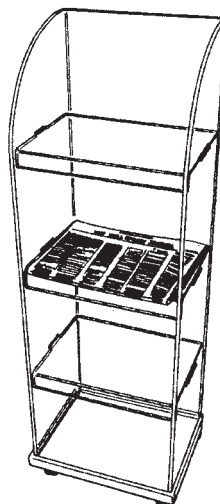

COMPETITION BOXES

Clear acrylic box with slot in top. Has a clear slide out lockable back that incorporates an A4 landscape signholder.

AP432 200mm (H) x 300mm (W) x 200mm (D)
Box size only Overall height including signholder - 400mm

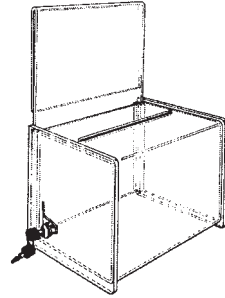

RAFFLE DRAWING ROTATOR

Octagonal shape clear acrylic box revolves on a heavy duty acrylic stand with non-skid clear feet. One side is a hinged door with camlock and slot for easy ticket removal. Has rotation locking feature the prevents the barrel rotating when reaching in for tickets.

AP359 350mm (H) x 550mm (W) x 300mm (D)

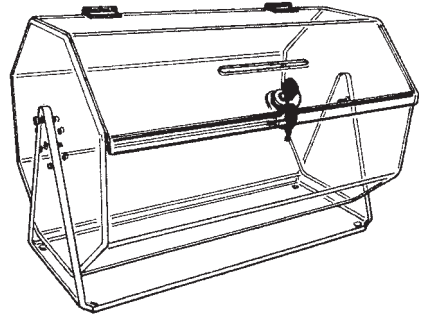

FOOD DISPLAY TUBES

Display a variety of food products, confectionery in these varying height tubes. Chose from angle cut open tubes or flat top tubes with lids.

AP717 200mm (H) x 150mm (Dia)

AP718 300mm (H) x 150mm (Dia)

AP719 450mm (H) x 150mm (Dia)

Angle cut

AP701 150mm (H) x 150mm (Dia)

AP702 240mm (H) x 150mm (Dia)

AP703 300mm (H) x 150mm (Dia)

Tubes with lids



BULK DISPLAY BINS

DIVIDED BIN DISPLAY

Angled-front bin display with four removable dividers to provide adjustable compartments. Ideal for a countertop display for packaged confectionery, jewellery accessories, etc.

AP650 200/125mm (H) x 580mm (W) x 200mm (D)
Up to 5 compartments - 110mm wide

AP652 200/125mm (H) x 800mm (W) x 200mm (D)
Up to 7 compartments - 110mm wide

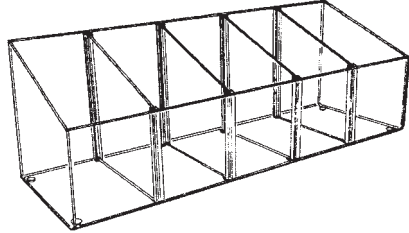

DIVIDED HEXAGONAL BIN

Four compartments. Supplied with separate clear adhesive feet so that unit can be placed for front or top opening.

AP655 200mm (H) x 580mm (W) x 240mm (D)

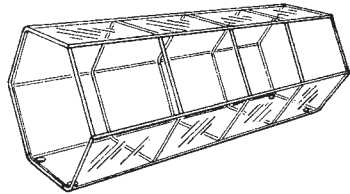

STACKABLE BULK BINS

These three sizes of bin can be used alone or together, either as a sloping back display or with the same unit on top of each other.

AP685 240mm (H) x 200mm (W) x 280mm (D)

AP686 240mm (H) x 200mm (W) x 400mm (D)

AP687 240mm (H) x 200mm (W) x 520mm (D)

AP688 Set of 3 units above - 1 of each size

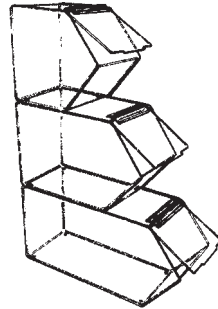

BREAD ROLL BIN

Large capacity unit with angled front hinged lid. Designed to stack on top of each other. Has air slot at back for circulation.

AP691 300mm (H) x 300mm (W) x 450mm (D)

AP693 300mm (H) x 900mm (W) x 450mm (D)

3 compartment unit - not pictured.

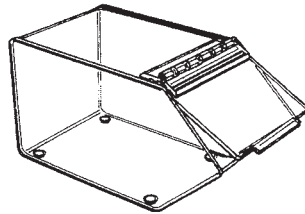

LARGE CAPACITY BULK UNIT

With hinged angled top lid. Ideal for bread rolls and other bulk products such as flour etc.

AP690 400mm (H) x 400mm (W) x 400mm (D)

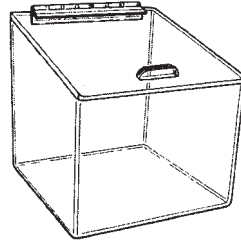

GRAVITY FED CONFECTIONERY UNIT

A proven performer over many years, this design incorporates a false front for product display with a removable baffle to retain slippery products. Hinged top lid for easy loading with hinged angled customer access lid.

AP683 300mm (H) x 150mm (W) x 330mm (D)

AP684 300mm (H) x 300mm (W) x 330mm (D)

AP684D 300mm (H) x 300mm (W) x 330mm (D)

With centre divider to form 2 compartments.

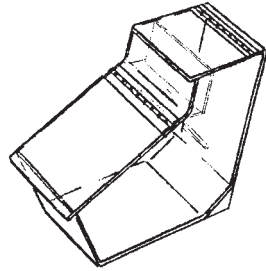

COFFEE BEAN DISPENSER

Hinged top loaded lid and spring-loaded dispensing door that closes when released. Designed to be mounted onto aluminium wall track.

AP710 450mm (H) x 175mm (W) x 300mm (D)

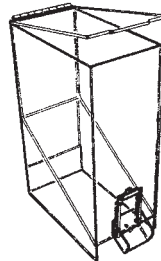

CEREAL DISPENSER

Hinged top loading lid and spring loaded dispensing door that retracts when released. Funnel system allows bowls to be filled easily and neatly.

AP712 600mm (H) x 240mm (W) x 300mm (D)

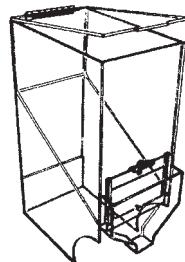

BAKERY CABINET ANGLED 2 TRAY

Angled front face acrylic cabinet includes two slide-out moulded trays (AP373 or 4) on angle.

AP720 355mm (H) x 380mm (W) x 280mm (D)
Includes 2 x AP373 trays.

AP721 355mm (H) x 470mm (W) x 355mm (D)
Includes 2 x AP374 trays.

AP720A 355mm (H) x 380mm (W) x 280mm (D)
Includes 2 x plain acrylic shelves.

AP721A 355mm (H) x 470mm (W) x 355mm (D)
Includes 2 x plain acrylic shelves.

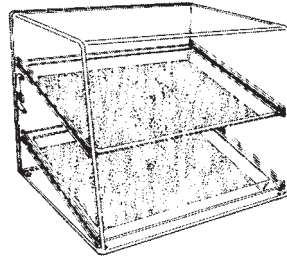

BAKERY CABINET ANGLED 3 TRAY

Angled front face acrylic cabinet includes three slide out moulded trays (AP373 or 4) on angle.

AP723 435mm (H) x 380mm (W) x 280mm (D)
Includes 3 x AP373 trays.

AP724 510mm (H) x 470mm (W) x 350mm (D)
Includes 3 x AP374 trays.

AP723A 435mm (H) x 380mm (W) x 280mm (D)
Includes 3 x plain acrylic shelves.

AP724A 510mm (H) x 470mm (W) x 350mm (D)
Includes 3 x plain acrylic shelves.

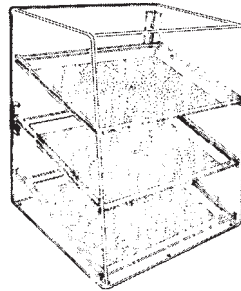

BAKERY CABINET STRAIGHT 3 TRAY

Includes 3 x slide out moulded trays (AP373 or 4).

AP726 435mm (H) x 280mm (W) x 400mm (D)
Includes 3 x AP373 trays.

AP727 510mm (H) x 330mm (W) x 190mm (D)
Includes 3 x AP374 trays.

AP726A 435mm (H) x 280mm (W) x 400mm (D)
Includes 3 x plain acrylic shelves.

AP727A 510mm (H) x 330mm (W) x 190mm (D)
Includes 3 x plain acrylic shelves.

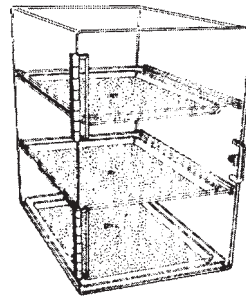

BAKERY CABINET TRAYS

Heavy duty injection-moulded trays are made of tough, clear plastic, suitable for repeated handling and washing.

AP373 365 x 280mm

AP374 455 x 330mm

